

## Cyclo® Bevel BuddyBox® 4 series

[www.sumitomodrive.com/BBB4](http://www.sumitomodrive.com/BBB4)

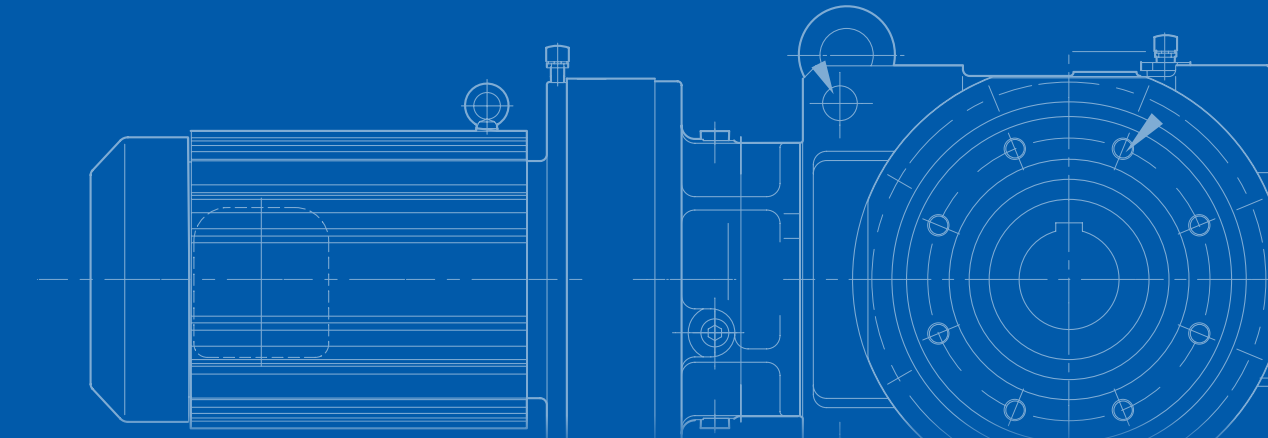

## Cyclo® Bevel BuddyBox® 4

Right Angle Spiral Bevel Speed Reducer  
with Cyclo® or Planetary Input  
4 Series

### Cyclo® Technology: Unparalleled Performance

Sumitomo's unique Cyclo® technology offers quiet, efficient and reliable operation with high torque density and compact size:

#### Cycloidal "Gearless" Speed Reduction

Torque transmitting parts roll, rather than grind, providing quiet, efficient and reliable performance

#### Superior Materials

52100 bearing grade steel rotating components, hardened to 58 Rockwell C for unmatched durability and reliability

#### Long Life and High Shock Load Capacity

The Cyclo® input has two-thirds of its reduction components in contact at all times, resulting in exceptionally rugged, shock resistant performance

#### Sumitomo Standard 24-month Warranty

Our standard warranty is not limited by hours of operation

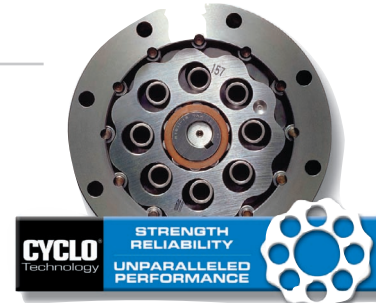

### Cyclo® BBB4 Applications

- |                                    |  |
|------------------------------------|--|
| Conveyors                          | Saw mills and timber processing machines |
| Mixers and agitators               | Roller mill drives                       |
| Bending and straightening machines | Paper machinery                          |
| Water treatment clarifiers         | Food and beverage machinery              |
| Construction machinery             | Metal working machines and pumps         |
| Crane and hoisting systems         | Recycling / waste management equipment   |



### Product Configurator: [www.sumitomodrive.com/Configurator](http://www.sumitomodrive.com/Configurator)

Trying to select a drive? Need more technical specifications? Need pricing?

Sumitomo Drive Technologies' online product Configurator streamlines the selection process, enabling you to build our power transmission products for your specific application.



Available 24 hours a day, 7 days a week, registered users quickly receive results that include:

- Downloadable 2D and 3D CAD files
- Product Literature
- Technical Specification Sheet
- Product Ratings
- Request for Quote\*
- Quotations\*

This unique interactive tool is one more reason Sumitomo Drive Technologies is the world's premier power transmission and control solutions provider.

\*Not available for all markets

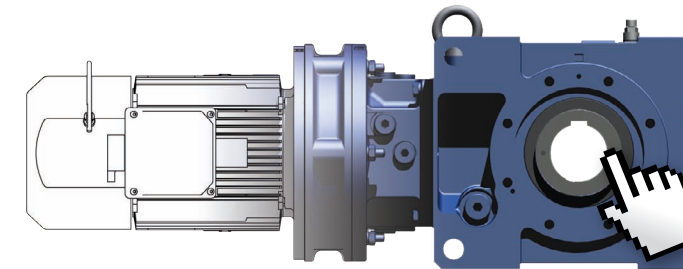

Configure your Cyclo® BBB4 today at  
[www.sumitomodrive.com/Configurator](http://www.sumitomodrive.com/Configurator)

### Sumitomo Americas

Sumitomo Machinery Corporation of America (SMA) is a subsidiary of Sumitomo Heavy Industries (SHI), the global leader in power transmission knowledge and innovation.

SMA began its operations in 1966 with a work force of ten people and an assembly facility of 5,000 ft<sup>2</sup> (465 m<sup>2</sup>). Today, our corporate headquarters in Chesapeake, VA (USA), combined with our strategic satellite locations throughout North, Central and South America occupy more than 500,000 ft<sup>2</sup> (46,500 m<sup>2</sup>) of office and manufacturing space. We ship thousands of drive products every month, adding to our North and South American installed base of more than five million units. SMA is committed to providing **Quality at Every Stage.**

#### USA - Headquarters & Manufacturing

4200 Holland Boulevard  
Chesapeake VA 23323  
Tel: 757-485-3355



Cyclo® BBB4 series is  
Made in the USA

Sumitomo Machinery Corporation of America

[www.sumitomodrive.com](http://www.sumitomodrive.com)

For facilities located in the Americas, please visit [www.sumitomodrive.com/locations](http://www.sumitomodrive.com/locations)

For worldwide locations, please visit [www.sumitomodrive.com/worldwide](http://www.sumitomodrive.com/worldwide)

Tel: 1-800-SM-CYCLO

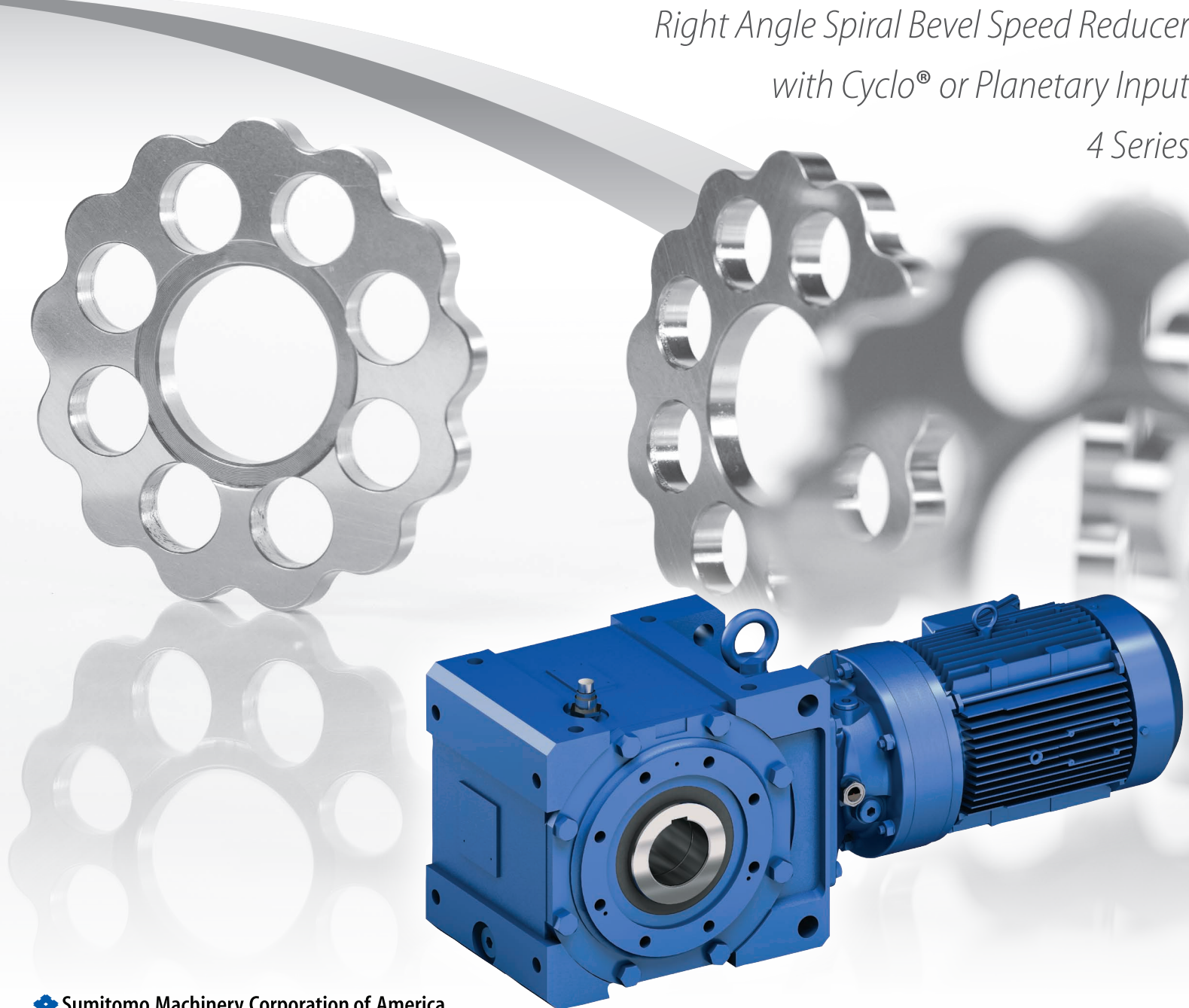

# Cyclo® Bevel BuddyBox® 4 Series

Right Angle Spiral Bevel Speed Reducers  
with Cyclo® or Planetary Reducer Inputs

The rugged Cyclo® BBB series features ductile iron housing for superior strength

The Cyclo® Bevel BuddyBox® 4 Series (Cyclo® BBB4) built by Sumitomo is a robust, state-of-the-art, mid-sized family of speed reducers and gearmotors. The Cyclo® BBB4 is a unique combination of features that result in a highly reliable, efficient and durable gearbox: the all-steel internal construction, Cyclo® or planetary gear inputs, and the ductile iron housing, provide unmatched ruggedness.

## Features for the Cyclo® Bevel BuddyBox® 4 Series

- ▶ **Ductile Iron Housing**  
Ductile iron housing is twice as strong as cast iron, making it one of the most rugged bevel gearboxes available
- ▶ **Optional Taconite Sealing System**  
Heavy-duty, fortified, grease purgeable system withstands the most demanding applications
- ▶ **Increased Overhung Load Capacity**  
Cyclo® BBB4 has over 375% more overhung load capacity than previous models
- ▶ **Increased Ratings**  
The newly redesigned Cyclo® BBB4 series has been optimized for increased power ratings over the previous generations
- ▶ **New Larger Frame Size**  
New F Size yields higher torque and can accommodate larger shaft diameters
- ▶ **New Ratios Available**  
46 standard and 87 optional ratios added

## Specifications Summary

**Sizes:** 6 frame sizes, 105 to 2329 lbs (48 to 1059 kg)  
**Torque Capacity:** Up to 159,983 lb-in (17,400 N-m)  
**HP Rating:** 1/8 to 100 HP (0.10 to 60 kW)  
**Ratio Range:** 11:1 to 26,000:1 and greater  
**Mounting:** Hollow Shaft, Foot, Flange, Face  
**Motor Standards:** NEMA, IEC, JIS, UL, CSA, CE

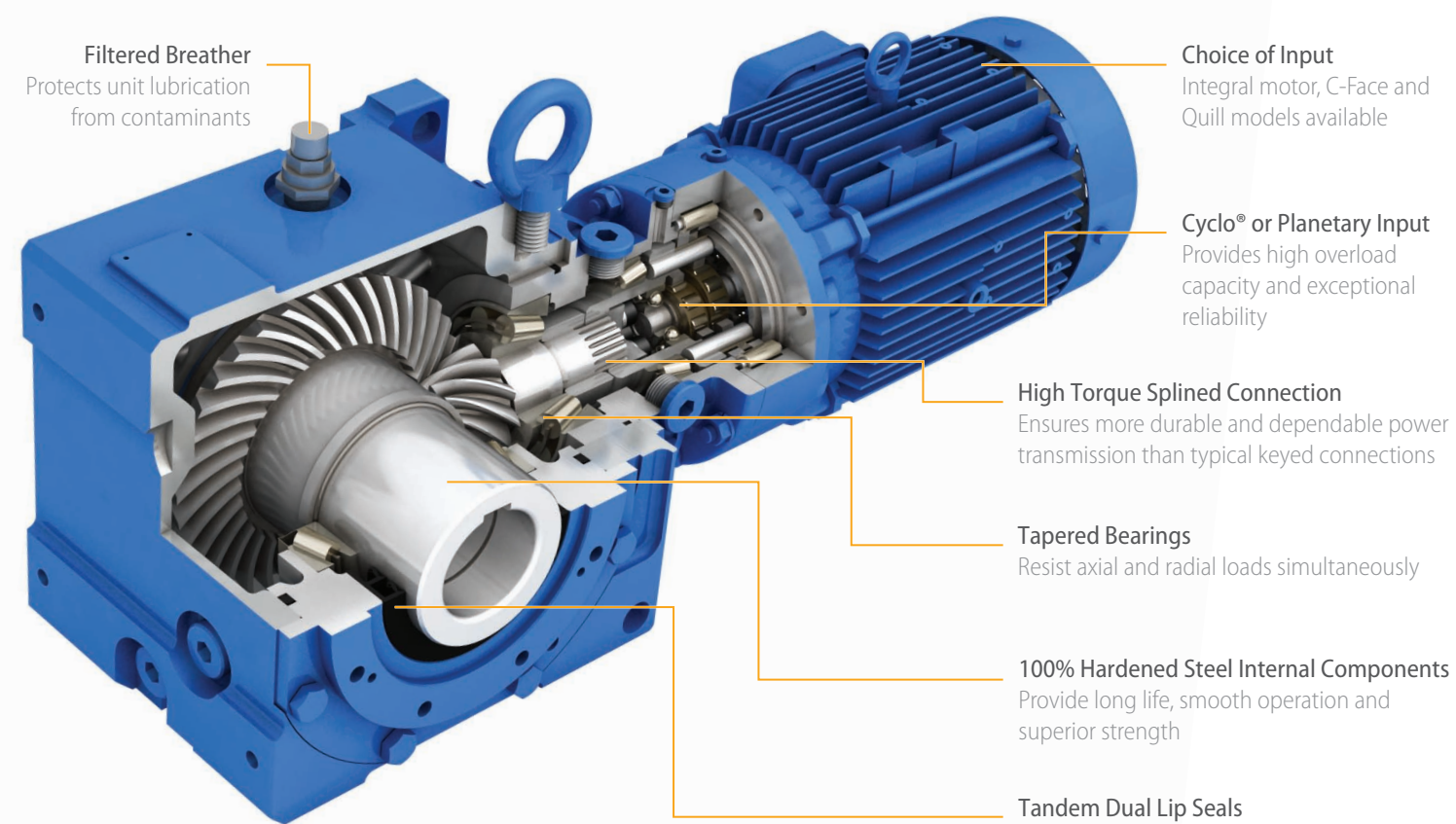

### Multiple Mounting Options

Foot, Flange and U Face mount are available options for the Cyclo® BBB4 Series.

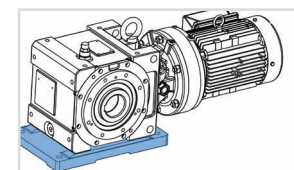

Foot

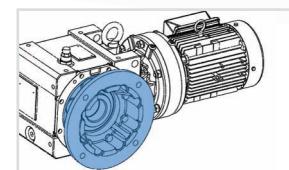

Flange

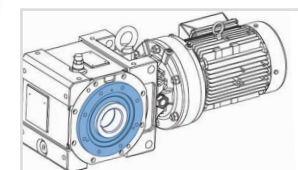

U Face

## Additional Features

- ▶ **Unified Lubrication System\***  
Cyclo® BBB4 features a single oil-bath lubrication system for easy maintenance and higher performance. This upgraded lubrication system provides the Cyclo® BBB4 series with higher ratings than previous generations.

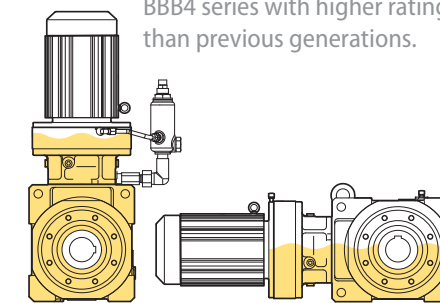

\*Unified lubrication system not available on motor-down mounting configurations

### Compact Design

The Cyclo® BBB4 offers a more torque-dense design in comparison to the standard industry right-angle drive. The new ductile iron housing allows for higher radial loads in a small, compact design.

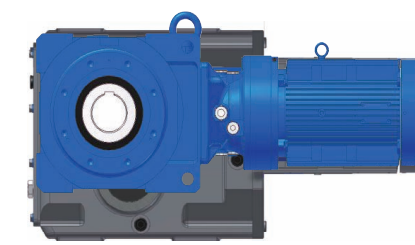

The Cyclo® BBB4 is a more compact series than most typical right angle shaft gearmotors in the same class.

## Input and Output Options

### Taper-Grip® Bushing

The patented Sumitomo Taper-Grip® bushing system enhances the Cyclo® BBB4 value by offering a simple shaft-mounting device that provides self-aligning, backlash-free torque transmission to the driven shaft.

The unique design provides easy unit mounting and removal from the driven shaft, and resistance to fretting and corrosion. Multiple stock bore sizes available for quick delivery.



Taper-Grip® Bushing

## Cyclo® Bevel BuddyBox® 4 Series Frame Size Details

Frame Size	POWER		BORE RANGE			
	Max Torque lb-in (N-m)	Max Motor Power HP (kW)	Taper-Grip® Bushing inch (mm)	Shrink Disc (mm)	Keyed Hollow Shaft inch (mm)	Solid Shaft inch (mm)
Size A*	9,470 (1,070)	25 (20)	1 to 2-1/4 (23 to 55)	(55)	1-1/4 to 2-3/16 (45 to 55)	2 (55)
Size B*	18,851 (2,130)	40 (29)	1-1/8 to 2-3/4 (30 to 65)	(65)	1-3/8 to 2-5/8 (55 to 65)	2-7/8 (65)
Size C*	37,701 (4,260)	75 (56)	1-1/2 to 3 (40 to 75)	(75)	2-3/16 to 3-3/16 (60 to 80)	3-1/8 (75)
Size D*	77,172 (8,720)	80 (60)	2-3/16 to 3-7/16 (55 to 85)	(85)	2-3/8 to 3-3/4 (70 to 90)	3-5/8 (85)
Size E*	102,660 (11,600)	100 (75)	2-11/16 to 4 (65 to 100)	(100)	2-15/16 to 4 (80 to 110)	4-7/16 (100)
Size F	153,990 (17,400)	100 (75)	3-15/16 to 4-15/16 (100 to 120)	(120)	3-7/16 to 4-3/4 (80 to 120)	4-3/4 (120)

\* Cyclo® BBB4 Frame Sizes A-E are dimensionally identical to the Cyclo® BBB3



Integral Motor



Quill Adapter

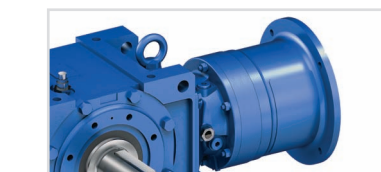

C-Face Adapter



Shrink Disc



Keyed Hollow Shaft



Solid Shaft